

## Package Contents



airFiber AF-11FX



Zip Ties (Qty. 2)



airFiber Gigabit PoE (50V,  
1.2A)



Power Cord

## Antenna Compatibility

The airFiber AF-11FX radio is designed for use with the airFiber X antenna model AF-11G35\*.

\* Check your local/regional regulations for the antenna gain allowed for your application

## Installation Requirements

- Clear line of sight between airFiber radios
- Vertical mounting orientation
- Mounting point:
  - At least 1 m below the highest point on the structure
  - For tower installations, at least 3 m below the top of the tower
- Ground wires – min. 10 AWG (5 mm<sup>2</sup>) and max. length: 1 m. As a safety precaution, ground the airFiber radio to grounded masts, poles, towers, or grounding bars.



**WARNING:** Failure to properly ground your airFiber radio will void your warranty.

- (Recommended) 2 Outdoor Gigabit PoE surge protectors



**Note:** For guidelines about grounding and lightning protection, follow your local electrical regulatory codes.

- High-Band Duplexer(s) (model AF-11FX-DUP-H) or Low-Band Duplexer(s) (model AF-11FX-DUP-L) are required for proper operation:
  - SISO mode: One Duplexer of either band type
  - MIMO mode: Two Duplexers of the same band type



**Note:** Duplexers must be purchased separately. The Duplexer(s) must match the terms of your license (frequency bands and polarities allowed).

- (Optional) If not using PoE: DC power source and 12/30 AWG power cable
- Outdoor, shielded Category 6 (or above) cabling and shielded RJ-45 connectors are required for all wired Ethernet connections.

## Hardware Overview

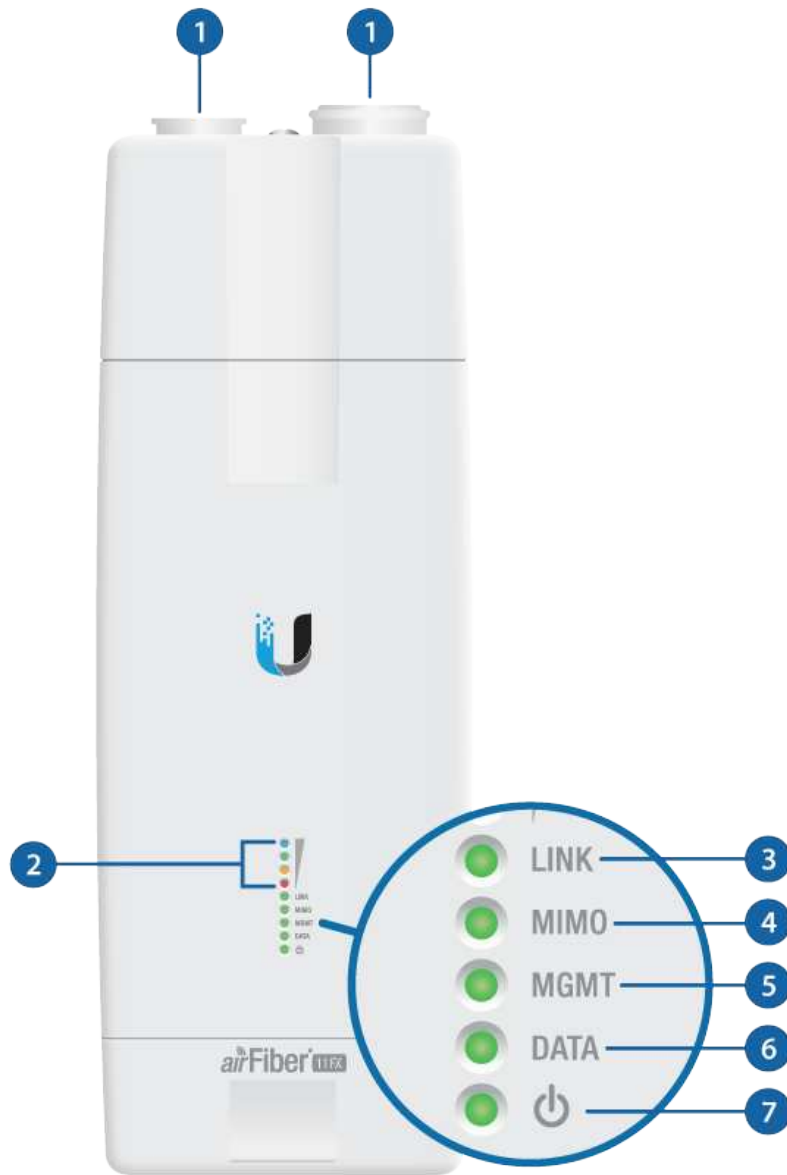





Low-Band Duplexer







High-Band Duplexer

### 1 Chain 0 / Chain 1

When the Chain 0 or Chain 1 duplexer is installed, its N-type connector is located here, allowing connection to an RF cable (Chain 1 is covered by the removable duplexer cap).

### 2 Signal LEDs

-  Signal 4 LED will light blue when on.
-  Signal 3 LED will light green when on.
-  Signal 2 LED will light yellow when on.
-  Signal 1 LED will light red when on.

**Bootup to airOS** When powering on, the Power, MIMO, LINK, and Signal 1-4 LEDs light on. Once the CPU code takes over, the MIMO, LINK, and Signal 1-3 LEDs turn off. Signal 4 LED remains lit to indicate the boot sequence is underway.



**Initializing airFiber Software** When the airFiber application begins to boot under airOS®, the Signal 4 LED goes from solidly on to a 2.5 Hz flash. This continues until the AF-11FX is fully booted.

**Signal Level** Once fully booted, the Signal 1-4 LEDs act as a bar graph showing how close the AF-11FX is to ideal aiming. This is auto-scaled based on the link range, the antenna gains, and the configured TX power of the remote AF-11FX. Each Signal LED has three possible states: On, Flashing, and Off. All Signal LEDs would be solidly on in an ideal link. For example, if the link has a 1 dB loss, the Signal 4 LED will flash; a 2 dB loss and the Signal 4 LED will turn off. The full bar graph LED states are shown below.

dB loss						
0	-1	-2	-3	-4	-5	-6
-7	-8	-9	-10	-11	-12	-13

### 3 Link LED

Off	RF Off
	Syncing

	Beaconing
	Registering
On	Operational
<b>4 MIMO LED</b>	
Off	Radio Configured in SISO Mode
On	Radio Configured in MIMO Mode
<b>5 MGMT LED</b>	
Off	No Ethernet Link
On	Ethernet Link Established
Random Flash	Ethernet Activity
<b>6 Data LED</b>	
Off	No Ethernet Link
On	Ethernet Link Established
Random Flash	Ethernet Activity
<b>7 Power LED</b>	
Off	No Power



On

Powered On

### 8 Management Port

10/100 Mbps, secured Ethernet port for configuration. In-Band Management is enabled by default in the airFiber Configuration Interface. When In-Band Management is disabled, the MGMT port is the only port that can monitor, configure, and/or update firmware.

### 9 Reset Button

To reset to factory defaults, press and hold the Reset button for more than 10 seconds while the device is already powered on.

### 10 Data Port

Gigabit PoE port for handling all user traffic and powering the device.

### 11 VDC IN

The terminal block can be used to power the AF-11FX with +50VDC, 1.2A instead of PoE.

### 12 TX 0, RX 0

The TX and RX SMA ports for the Chain 0 Low-Band Duplexer or High-Band Duplexer (SISO and MIMO modes).

### 13 RX 1, TX 1

The RX and TX SMA ports for the Chain 1 Low-Band Duplexer or High-Band Duplexer (MIMO mode only). In SISO mode, these unused ports are protected by

the duplexer cap.

#### 14 N Connector

Female N-type connector into which the antenna cable is plugged.

#### 15 SMA Port

High-band and low-band channel SMA ports.



**Note:** Duplexers are not included with the AF-11FX. SISO mode requires one Low-Band Duplexer or one High-Band Duplexer. MIMO mode requires either two Low-Band Duplexers or two High-Band Duplexers.

## Installation Overview

We recommend that you configure your paired AF-11FX radios before site installation. The overview below summarizes the installation procedure, and the subsequent sections provide detailed installation information.

- Install the Duplexer(s) in the AF-11FX radio.
- Connect the airFiber Gigabit PoE adapter to the DATA port, and connect your computer to the MGMT port.
- Configure the AF-11FX.
- Install a ground wire and mount the AF-11FX on the airFiber AF-11G35 antenna (or a compatible antenna).
- At the installation site, install the antenna with the mounted AF-11FX radio (see the antenna's Quick Start Guide for installation instructions).
- Connect the DATA port to your LAN, and connect power (PoE or DC power) to the AF-11FX.
- Establish and optimize the RF link.

# Installing the Duplexers

## Installing the Duplexer for SISO Mode

- 1.



2.

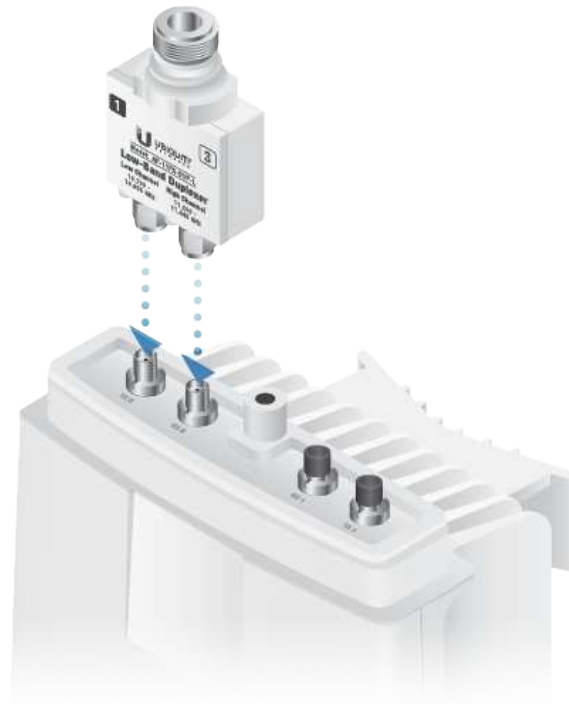

**Note:** Position the low channel and high channel ports to yield the required transmit and receive frequencies.

3.



**!** **WARNING:** Tighten the collars alternately, a half turn at a time, until both are fully tightened. Failure to do so may result in damage to the Duplexer.

4.



5. Repeat steps 1-4 for the radio to be used on the other end of the link, ensuring that the numbers on the second radio's Duplexer are in the reverse order of the numbers on first radio's Duplexer.



**Note:** For example, if the numbers on the first radio's Duplexer are (left to right) 1/3, then the numbers on the second radio's Duplexer should be 3/1.

## Installing the Duplexers for MIMO Mode



**Note:** MIMO operation requires two licenses, one per polarization and two Duplexers of the same band type.

1.

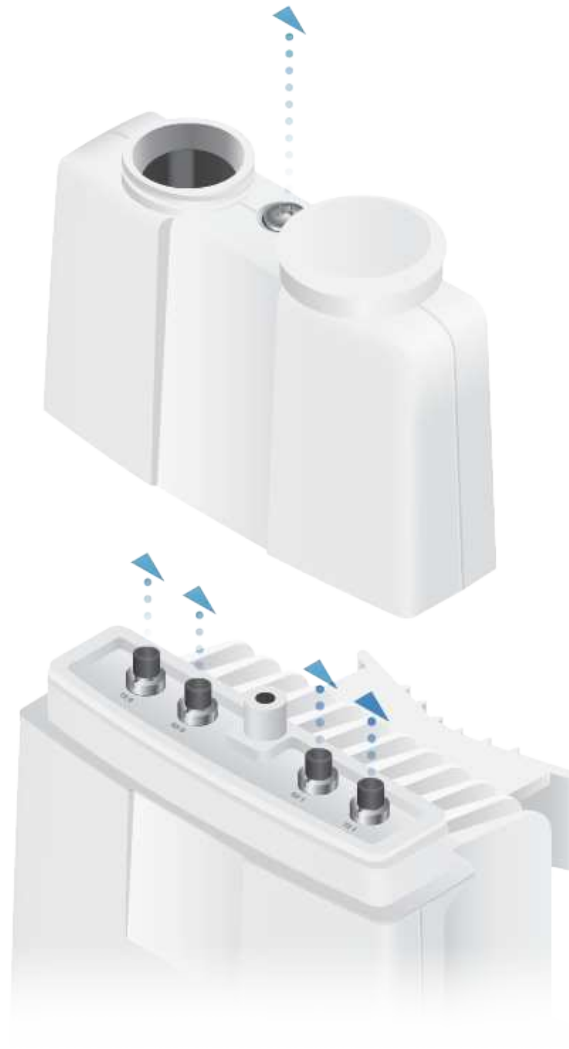

2.



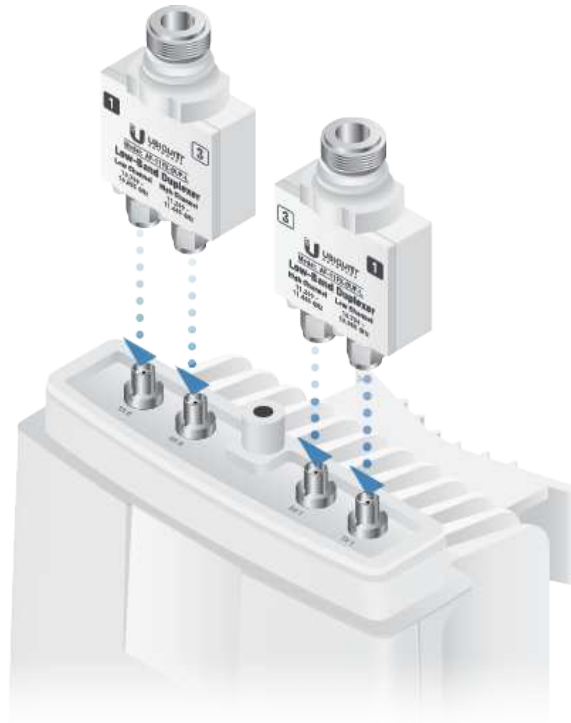

**Note:** Position the low channel and high channel ports to yield the required transmit and receive frequencies. Also, ensure that the numbers on the right-side Duplexer are in the reverse order of the numbers on the left-side Duplexer.

3.



**!** **WARNING:** Tighten the collars alternately, a half turn at a time, until both are fully tightened. Failure to do so may result in damage to the Duplexer.

4.



5.



6. Repeat steps 1-5 for the other radio to be used in the link, ensuring that the numbers on the second radio's Duplexers are in the reverse order of the numbers on the first radio's Duplexers.



**Note:** For example, if the numbers on the first radio's Duplexers are (left to right) 2/4 and 4/2, the numbers on the second radio's Duplexers should be 4/2 and 2/4.

## Connecting Power over Ethernet

- 1.



2.

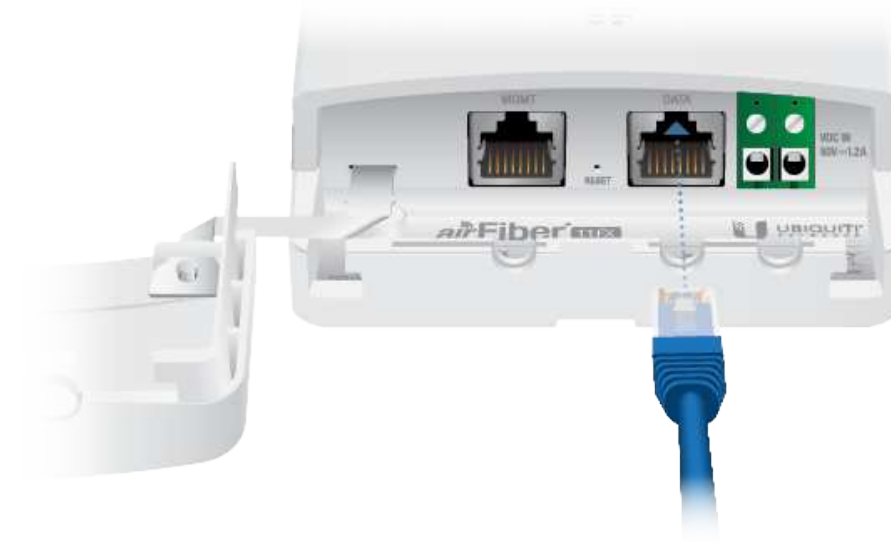

3.

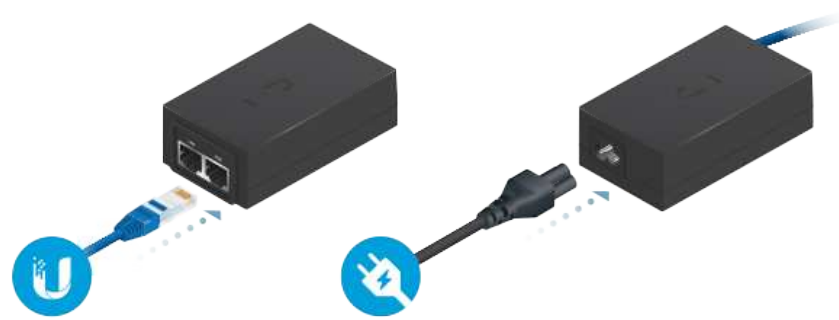

 **WARNING:** Use only the included adapter, model POE-50-60W. Failure to do so can damage the unit and void the product warranty.

## airFiber Configuration

Access the airFiber Configuration Interface and configure the following settings:

- **Wireless Mode** Configure one AF-11FX as the Master and the other as the Slave.
- **Frequency Setting** The TX Frequency and RX Frequency settings must be the reverse of each other on both the Master and the Slave.

1.



2. Configure the Ethernet adapter on your computer with a static IP address on the 192.168.1.x subnet.
3. Launch your web browser. Type `https://192.168.1.20` in the address field and press enter (PC) or return (Mac).

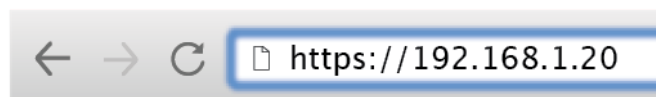

4. The login screen will appear. Enter `ubnt` in the Username and Password fields. Select your Country and Language. You must agree to the Terms of Use to use the product. Click Login.

U aFiber

### Login

Please login to manage your wireless device.

**Username**  
Username

**Password**  
Password

**Country**  
Select Your Country

**Language**  
English

**TERMS OF USE**

This Ubiquiti Networks, Inc. radio device must be professionally installed. Properly installed shielded Ethernet cable and earth grounding must be used as conditions of product warranty. It is the installer's responsibility to follow local country regulations including operation within legal frequency channels, output power, and Dynamic Frequency Selection (DFS) requirements. You are responsible for keeping the unit working according to these rules.

You must also read and agree to the terms of the [UBIQUITI FIRMWARE LICENSE AGREEMENT](#) in the link below before you can download or install or use the Ubiquiti aFiber™ Firmware.

[UBIQUITI FIRMWARE LICENSE AGREEMENT](#)

I agree to these [TERMS OF USE](#) and the [UBIQUITI FIRMWARE LICENSE AGREEMENT](#)

LOGIN

5. Click  Settings, and then click the Wireless tab.



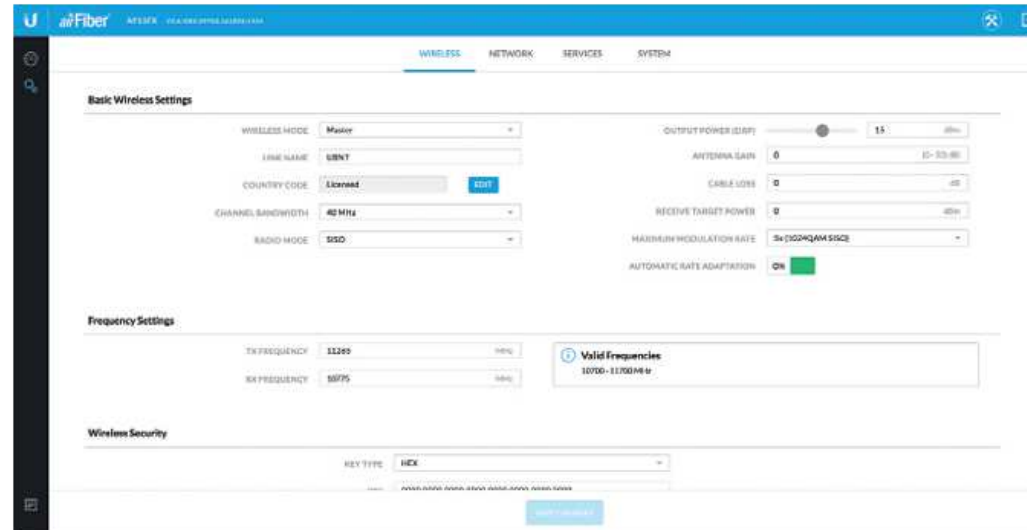

6. Configure the Basic Wireless Settings:
  - a. For one AF-11FX, select Master as the Wireless Mode. For the other AF-11FX, keep the default, Slave.
  - b. Enter a name in the Link Name field. This should be the same on both the Master and the Slave.
  - c. If needed, change the Channel Bandwidth, Output Power and/or Maximum Modulation Rate settings.
7. Configure the TX Frequency and RX Frequency.



**Note:** One airFiber radio's TX Frequency is the other radio's RX Frequency, and vice versa.

8. Configure the Wireless Security:
  - a. Select the Key Type, HEX or ASCII.
  - b. For the Key field:

- **HEX** Enter 16 bytes (eight, 16-bit hexadecimal digits: 0-9, A-F, or a-f). You can omit zeroes and use colons, similar to the IPv6 format.



**Note:** The airFiber Configuration Interface supports IPv6 formats excluding dotted quad and “::” (double-colon) notation.

- **ASCII** Enter a combination of alphanumeric characters (0-9, A-Z, or a-z).

9. Click Save Changes.

10. In-Band Management is enabled by default, so each airFiber radio must have a unique IP Address. (If the airFiber radios use the same IP Address, you may lose access to the airFiber radios via the DATA ports.) Click the Network tab.

a. For the Management IP Address option:

- **DHCP** Keep the default, DHCP, to use DHCP reservation on your router to assign a unique IP Address.
- **Static** Change the IP Address, Netmask, and other settings to make them compatible with your network.

b. Click Save Changes.

11. Disconnect the Ethernet cables from the MGMT and DATA ports on the AF-11FX. Configuration of the AF-11FX radio is complete.

Repeat the instructions in the airFiber Configuration section on the other AF-11FX radio.

For details on the airFiber Configuration Interface, refer to the airFiber AF-11FX User Guide, available at: [ui.com/download/airfiber](http://ui.com/download/airfiber)

## Hardware Installation

### Install a Ground Wire

- 1.

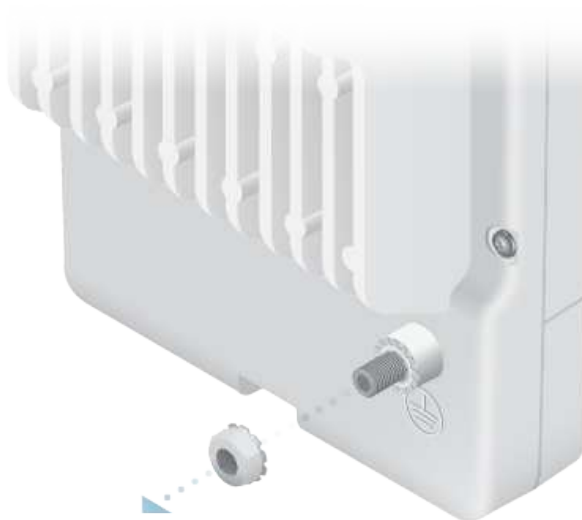

- 2.



3. At the installation site, secure the other end of the ground wire to a grounded mast, pole, tower, or grounding bar.



**WARNING:** Failure to properly ground your airFiber radio will void your warranty.



**Note:** The ground wire should be as short as possible and no longer than one meter in length.

## Mount to the airFiber AF-11G35 Antenna

1. Attach an RF Cable to an RF connector labeled H or V. Then slide the silicone boot over the RF connector to protect it.



**Note:** For SISO mode, use the RF connector (H or V) as determined by your licensing. Keep the other RF connector covered with the included Metal Cap.

If using MIMO mode, remove the cap over the second RF connector (V or H) and attach an RF Cable. Then slide the silicone boot over the RF connector to protect it.

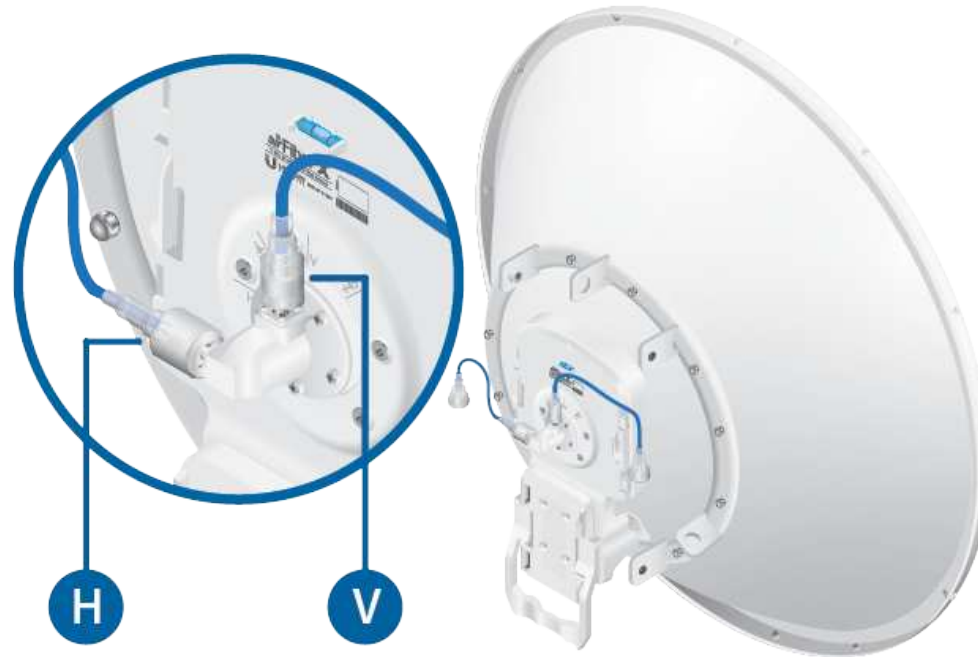

- 2.

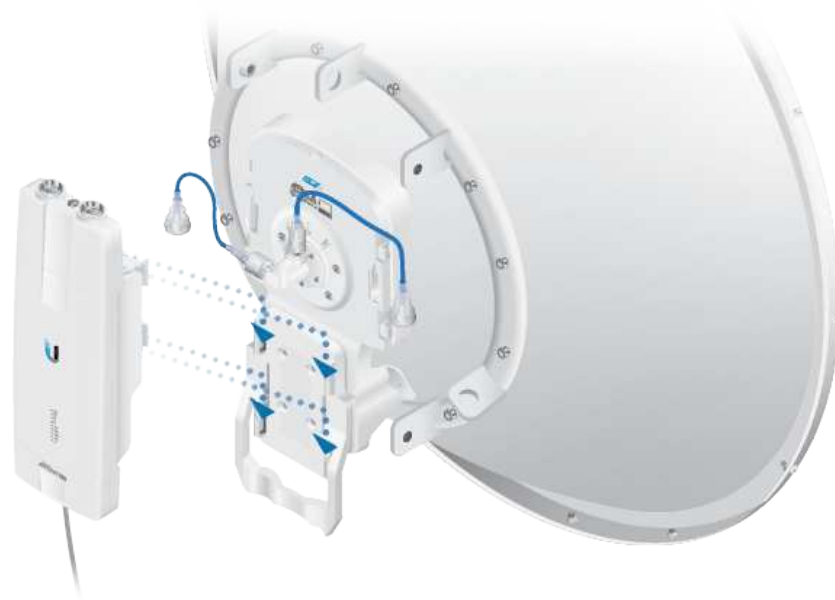

3.



4.



**Note:** Align the dot on the side of the shroud with the arrowhead on the dish antenna.

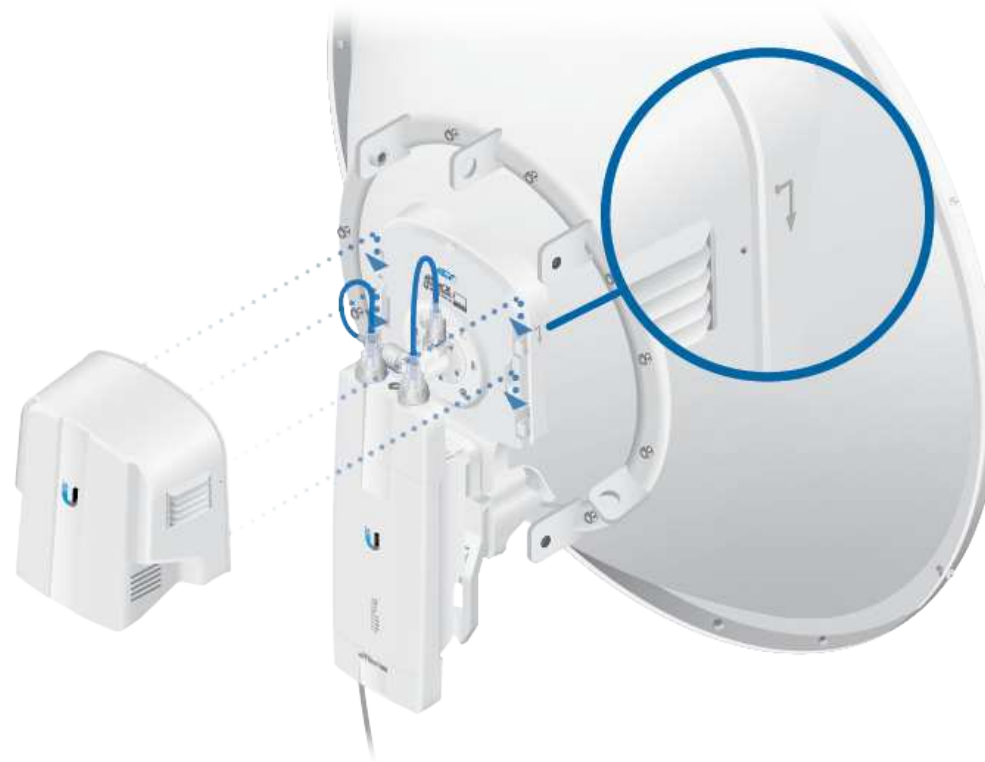

## Connecting Data

1.



2.





3. If you are using DC power, connect the other end of the Ethernet cable to your LAN.

## Connecting Power

Follow the instructions for the source of power that you are using: Power over Ethernet or DC Power.

### Power Over Ethernet



**WARNING:** Use only the included adapter, model POE-50-60W. Failure to do so can damage the unit and void the product warranty.



## DC Power

1. Connect a DC power cable to the Terminal Block. (The +VDC and GND can be connected to either terminal.)



2. Connect the other end of the DC power cable to a DC power supply that supplies +50VDC.



**WARNING:** Applying a negative voltage such as -48VDC will damage the radio.

3. Connect the DC power supply to its source.

## Surge Protection

For added protection, install two surge suppressors, such as the Ubiquiti Ethernet Surge Protector, model ETH-SP-G2, at the end of each link. Install the first surge protector within one meter of the airFiber DATA port, and install the second surge protector at the ingress point of the location housing the wired network equipment.

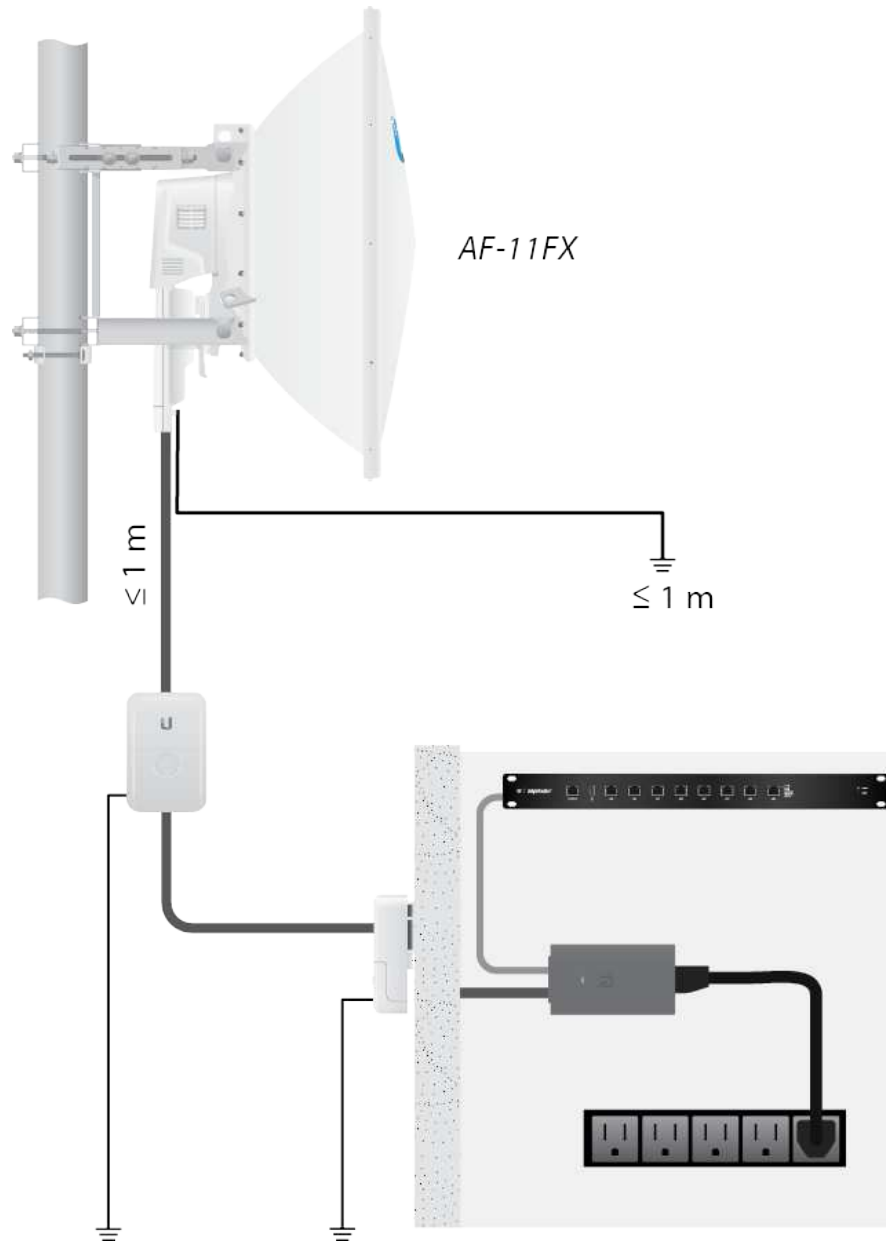

# Alignment

## Tips

- To accurately align the airFiber radios for best performance, you **MUST** align only one end of the link at a time.
- You may need to use additional hardware to compensate for issues such as the improper orientation of a mounting pole or significant elevation differences between airFiber radios.

## Establishing a Link

Adjust the positions of the Master and the Slave to establish a link. The following section features the airFiber X antenna, AF-11G35:



**Note:** The Master must be aimed first at the Slave because the Slave does not transmit any RF signal until it detects transmissions from the Master.

1. **Master** Visually aim the Master at the Slave. To adjust the Master's position, adjust the azimuth and the elevation.

Adjust the azimuth:

- a. Loosen the four flange nuts on the two pole clamps.
- b. Rotate the antenna to point towards the other end of the link.
- c. Tighten the four flange nuts on the two pole clamps.

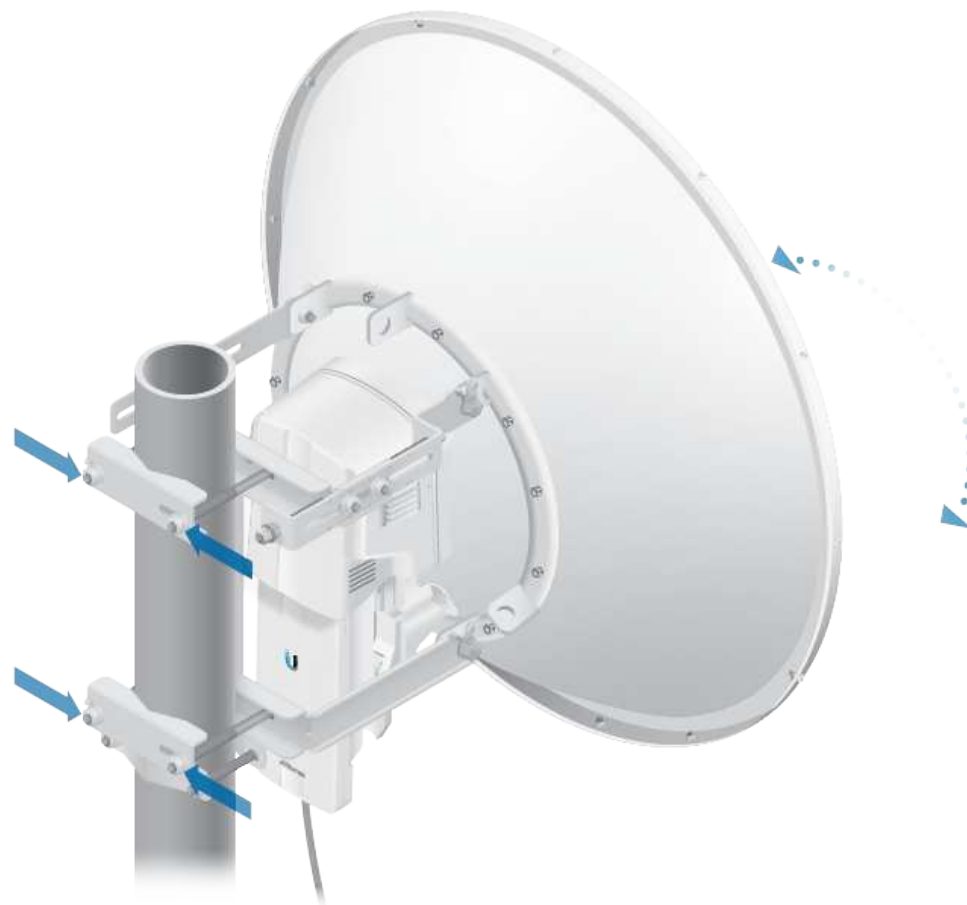

Adjust the elevation angle:

- a. Loosen the eight hex head bolts to so that the washers can spin freely by hand.
- b. Tighten or loosen the Elevation Adjustment Bolt to set the desired tilt.
- c. Tighten the eight hex head bolts.



**Note:** Do NOT make simultaneous adjustments on the Master and Slave.

2. **Slave** Visually aim the Slave at the Master. To adjust the Slave's position, adjust the azimuth and elevation as described in step 1.
3. Check to see if a link is established. Ensure that the LINK LED is solidly lit green and the Signal LEDs of the Slave are displaying signal levels.



4. **Slave** Aim the Slave at the Master to achieve the strongest signal level on the Master.



**Note:** Refer to the Signal LEDs section for details on the signal values.



**Note:** Maximum signal strength can best be achieved by iteratively sweeping through both azimuth and elevation.

5. **Master** Aim the Master at the Slave to achieve the strongest signal level on the Slave.
6. Repeat steps 4 and 5 until you achieve an optimal link, with all four Signal LEDs solidly lit. This ensures the best possible data rate between the airFiber radios.
7. Lock the alignment on both airFiber antennas by tightening all the nuts and bolts.
8. Observe the Signal LEDs of each airFiber radio to ensure that the values remain constant while tightening the nuts and bolts. If any LED value changes during the locking process, loosen the nuts and bolts, finalize the alignment of each airFiber antenna again, and retighten the nuts and bolts.



For detailed information on setting up an airFiber link, see the airFiber AF-11FX User Guide available at: [ui.com/download/airfiber](http://ui.com/download/airfiber)

## Installer Compliance Responsibility

Devices must be professionally installed and it is the professional installer's responsibility to make sure the device is operated within local country regulatory requirements.

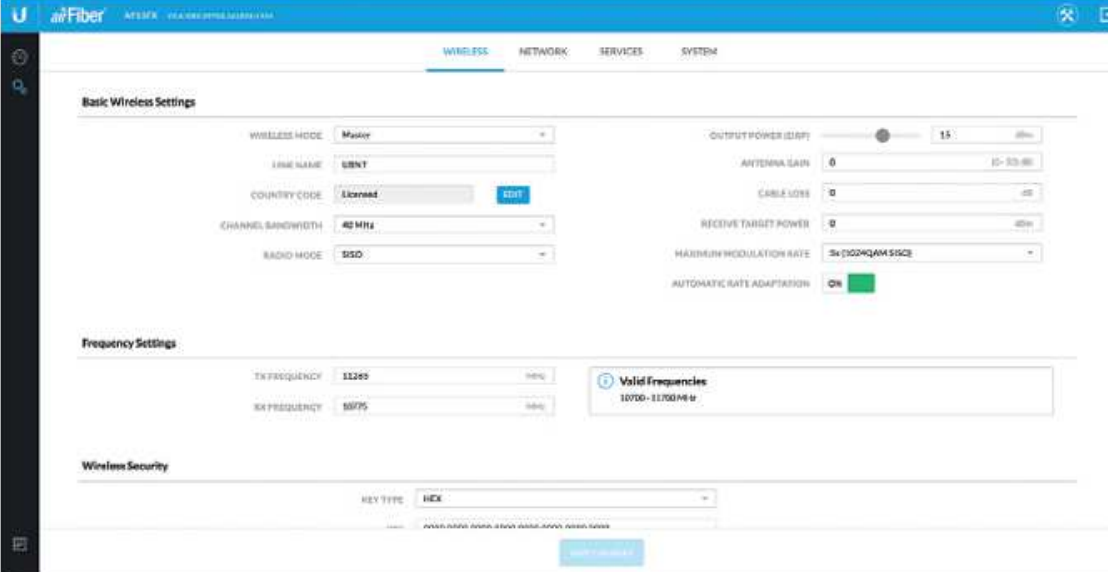

The screenshot displays the 'Basic Wireless Settings' page in the airFiber AF-11FX web interface. The page is organized into several sections:

- Basic Wireless Settings:** Includes fields for 'WIRELESS MODE' (set to Master), 'LINE NAME' (set to USN1), 'COUNTRY CODE' (set to Licensed), 'CHANNEL BANDWIDTH' (set to 40 MHz), and 'RADIO MODE' (set to SISO). On the right, there are sliders and input fields for 'OUTPUT POWER (dBm)' (set to 15), 'ANTENNA GAIN' (set to 0), 'CABLE LOSS' (set to 0), 'RECEIVE TARGET POWER' (set to 0), 'MAXIMUM MODULATION RATE' (set to 3x (1024QAM 515Q2)), and 'AUTOMATIC RATE ADAPTATION' (set to ON).
- Frequency Settings:** Includes 'TX FREQUENCY' (set to 11200 MHz) and 'RX FREQUENCY' (set to 11775 MHz). A 'Valid Frequencies' box shows the range 10700 - 11700 MHz.
- Wireless Security:** Includes a 'KEY TYPE' dropdown set to HEX and a corresponding key field.

The Output Power, Antenna Gain, Cable Loss\*, TX Frequency and RX Frequency fields are provided to the professional installer to assist in meeting regulatory requirements.

\* Cable Loss includes loss due to the Duplexer(s).

## Specifications

airFiber AF-11FX

airFiber AF-11FX	
Dimensions	327 x 112 x 86 mm (12.87 x 4.41 x 3.39")
Weight	2.26 kg (5.0 lb)
RF Connectors	(4) SMA Weatherproof, Two per Chain: TX 0, RX 0 (Chain 0) and TX 1, RX 1 (Chain 1) (2) N-Type Waterproof, One per Duplexer
Power Supply	50V, 1.2A PoE Gigabit Adapter (Included)
Power Method	Passive Power over Ethernet, DC Power Block
Supported Voltage Range	38-56VDC
Certifications	FCC Part 101, ETSI EN 302 217
Mounting	AF-11G35 Mount Compatible
Operating Temperature	-40 to 55° C (-40 to 131° F)
Networking Interface	
Data	(1) 10/100/1000 Ethernet Port
Management	(1) 10/100 Ethernet Port

System	
Processor	INVICTUS™ 2 IC
Maximum Throughput	1.2+ Gbps
Encryption	128-bit AES
OS	airOS F
Wireless Modes	SISO/MIMO

Radio	

Radio	
Operating Frequency	10.7-11.7 GHz (Depends on Regulatory Region <sup>1</sup> )
Max. Conducted TX Power	30 dBm (Depends on Regulatory Region <sup>1</sup> )
Frequency Accuracy	± 1 ppm
Channel Bandwidth	3.5/5/7/10/14/20/28/30/40/50/56 MHz Selectable <sup>2</sup> Programmable Uplink and Downlink Duty Cycles

<sup>1</sup> For region-specific details, refer to the Compliance chapter of the airFiber AF-11FX User Guide at [ui.com/download/airfiber](http://ui.com/download/airfiber)

<sup>2</sup> Channel widths may vary according to country/region regulations.

## Safety Notices

1. Read, follow, and keep these instructions.
2. Heed all warnings.
3. Only use attachments/accessories specified by the manufacturer.



**WARNING:** Do not use this product in location that can be submerged by water.



**WARNING:** Avoid using this product during an electrical storm. There may be a remote risk of electric shock from lightning.

## Electrical Safety Information

1. Compliance is required with respect to voltage, frequency, and current requirements indicated on the manufacturer's label. Connection to a different power source than those specified may

result in improper operation, damage to the equipment or pose a fire hazard if the limitations are not followed.

2. There are no operator serviceable parts inside this equipment. Service should be provided only by a qualified service technician.
3. This equipment is provided with a detachable power cord which has an integral safety ground wire intended for connection to a grounded safety outlet.
  - a. Do not substitute the power cord with one that is not the provided approved type. Never use an adapter plug to connect to a 2-wire outlet as this will defeat the continuity of the grounding wire.
  - b. The equipment requires the use of the ground wire as a part of the safety certification, modification or misuse can provide a shock hazard that can result in serious injury or death.
  - c. Contact a qualified electrician or the manufacturer if there are questions about the installation prior to connecting the equipment.
  - d. Protective earthing is provided by Listed AC adapter. Building installation shall provide appropriate short-circuit backup protection.
  - e. Protective bonding must be installed in accordance with local national wiring rules and regulations.

## Limited Warranty

[ui.com/support/warranty](https://ui.com/support/warranty)

The limited warranty requires the use of arbitration to resolve disputes on an individual basis, and, where applicable, specify arbitration instead of jury trials or class actions.

## Compliance

### FCC / CAN ICES-3(A)/NMB-3(A)

The AF-11FX has been verified by Ubiquiti Inc. as being in compliance with the requirements of the rules of the Federal Communications Commission (FCC), 47 C.F.R. Part 101, and may not be operated without a station license. In the United States such licenses are issued by the FCC to entities other than agencies of the United States government. Federal government agencies are

licensed by the National Telecommunications and Information Administration (NTIA) acting upon the recommendation of the Interdepartment Radio Advisory Committee (IRAC).

## Frequency Plan

The AF-11FX frequency plan is compliant with FCC and IC specifications, as listed in the following table:

Band	11 GHz
Frequency Range (GHz)	10.7 - 11.7
Bandwidth (MHz)	3.5, 5, 10, 30, 40, 80
T/R Spacing (MHz)	490, 500
Reference	FCC Part 101.147

## IMPORTANT NOTE

### Radiation Exposure Statement

- This equipment complies with radiation exposure limits set forth for an uncontrolled environment.
- This equipment should be installed and operated with minimum distance 270 cm between the radiator and your body.
- This transmitter must not be co-located or operating in conjunction with any other antenna or transmitter.

## AVIS IMPORTANT

### Déclaration sur l'exposition aux rayonnements

- Cet équipement est conforme aux limites prévues pour l'exposition aux rayonnements dans un environnement non contrôlé.

- Lors de l'installation et de la mise en fonctionnement de l'équipement, assurez-vous qu'il y ait une distance minimale de 270 cm entre l'élément rayonnant et vous.
- Cet émetteur ne doit être installé à proximité d'aucune autre antenne ni d'aucun autre émetteur, et ne doit être utilisé conjointement à aucun autre de ces appareils.

## Australia and New Zealand



Warning: This equipment is compliant with Class A of CISPR 32. In a residential environment this equipment may cause radio interference.

## Brazil



Nota: Este equipamento não tem direito à proteção contra interferência prejudicial e não pode causar interferência em sistemas devidamente autorizados.

## CE Marking

CE marking on this product represents the product is in compliance with all directives that are applicable to it.



Country List



AT	BE	BG	CY	CZ	DE	DK	EE	EL	ES	FI	FR	HR	HU
IE	IT	LV	LT	LU	MT	NL	PL	PT	RO	SE	SI	SK	UK

BFWA (Broadband Fixed Wireless Access) members noted in blue



Note: This device meets Max. TX power limit per ETSI regulations.

[WEEE Compliance Statement](#)

[Declaration of Conformity](#)

[Online Resources](#)



© 2020 Ubiquiti Inc. All rights reserved.