



**airMAX<sup>®</sup>**  
TITANIUM SECTOR

Advanced RF Isolation Variable Beamwidth Antenna

Models: AM-V2G-Ti, AM-V5G-Ti, AM-M-V5G-Ti

Carrier-Class 2x2 MIMO PtMP BaseStation

---

Adjustable Beamwidth Configuration

---

Reduced Co-Location Interference

---

# airMAX®

## TITANIUM SECTOR

### Advanced Carrier-Class PtMP Basestation Antenna

Introducing the airMAX® Titanium Sector, which continues the evolution of Ubiquiti's best-in-class sector antennas. Advanced RF isolation and variable beamwidth configuration put the Titanium Sector at the forefront of sector antenna technology.

### Reduced Co-Location Interference

Drawing on Ubiquiti's depth of electrical and mechanical engineering expertise, Ubiquiti has developed the airMAX Titanium Sector to be highly resistant to noise interference in co-location deployments.

### Adjustable Beamwidth Configuration

Having adjustable beamwidth options enhances scalability and streamlines inventory. The airMAX Titanium Sector may be custom configured for any deployment requiring a 60°, 90°, or 120° sector.

Antenna gain changes according to the configured beamwidth.

Model	60°	90°	120°
AM-V2G-Ti	17 dBi	16 dBi	15 dBi
AM-V5G-Ti	21 dBi	20 dBi	19 dBi
AM-M-V5G-Ti	17 dBi	16 dBi	15 dBi

### Easily Mount and Protect Your Rocket

The Titanium Sector has an integrated Rocket mount that allows you to mount the Rocket without the use of any tools. The custom-designed Protective Shroud helps to shield your Rocket from the elements.

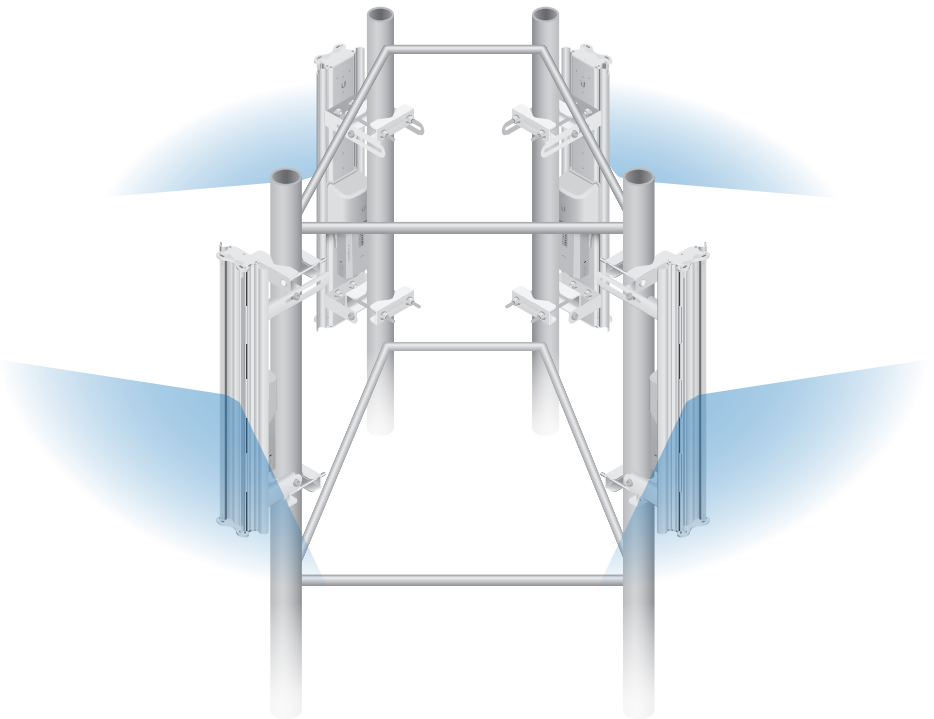

*Ideal for Co-Location Deployments*

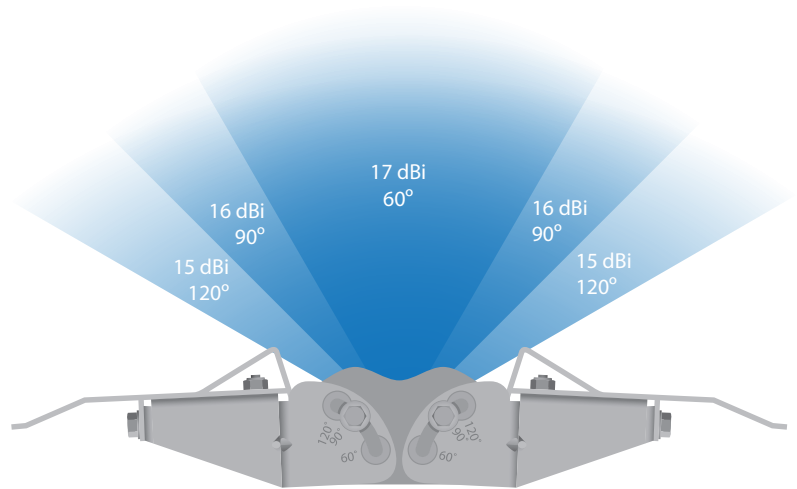

*AM-V2G-Ti Adjustable Beamwidth*

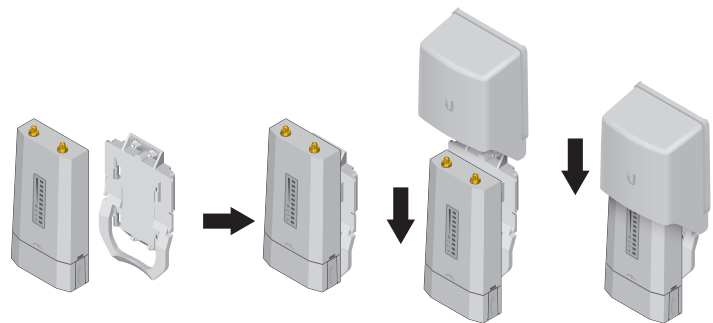

*Integrated Rocket Mount*

# Overview

Model: AM-V2G-Ti

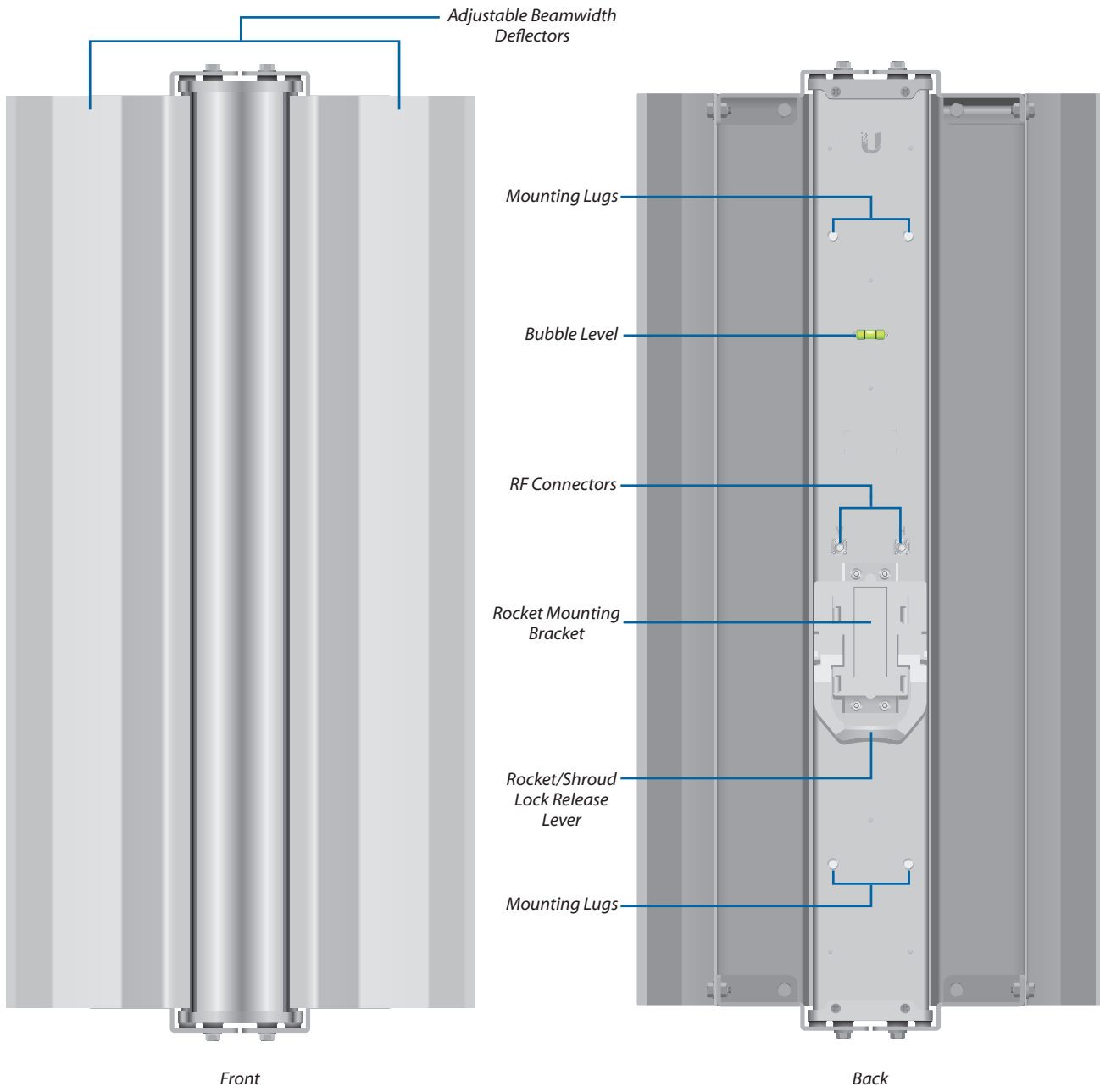

Model: AM-V5G-Ti

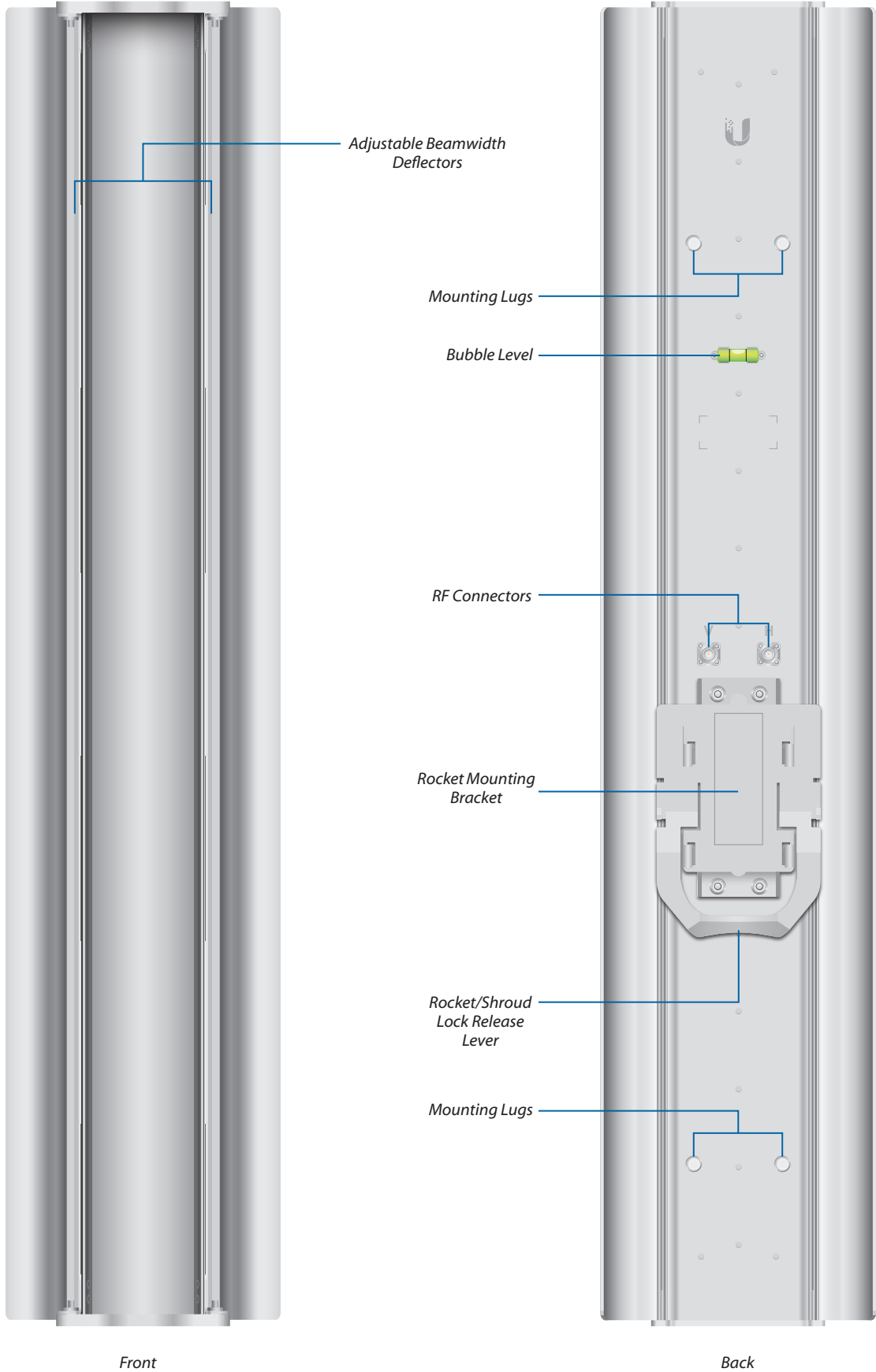

**Model: AM-M-V5G-Ti**

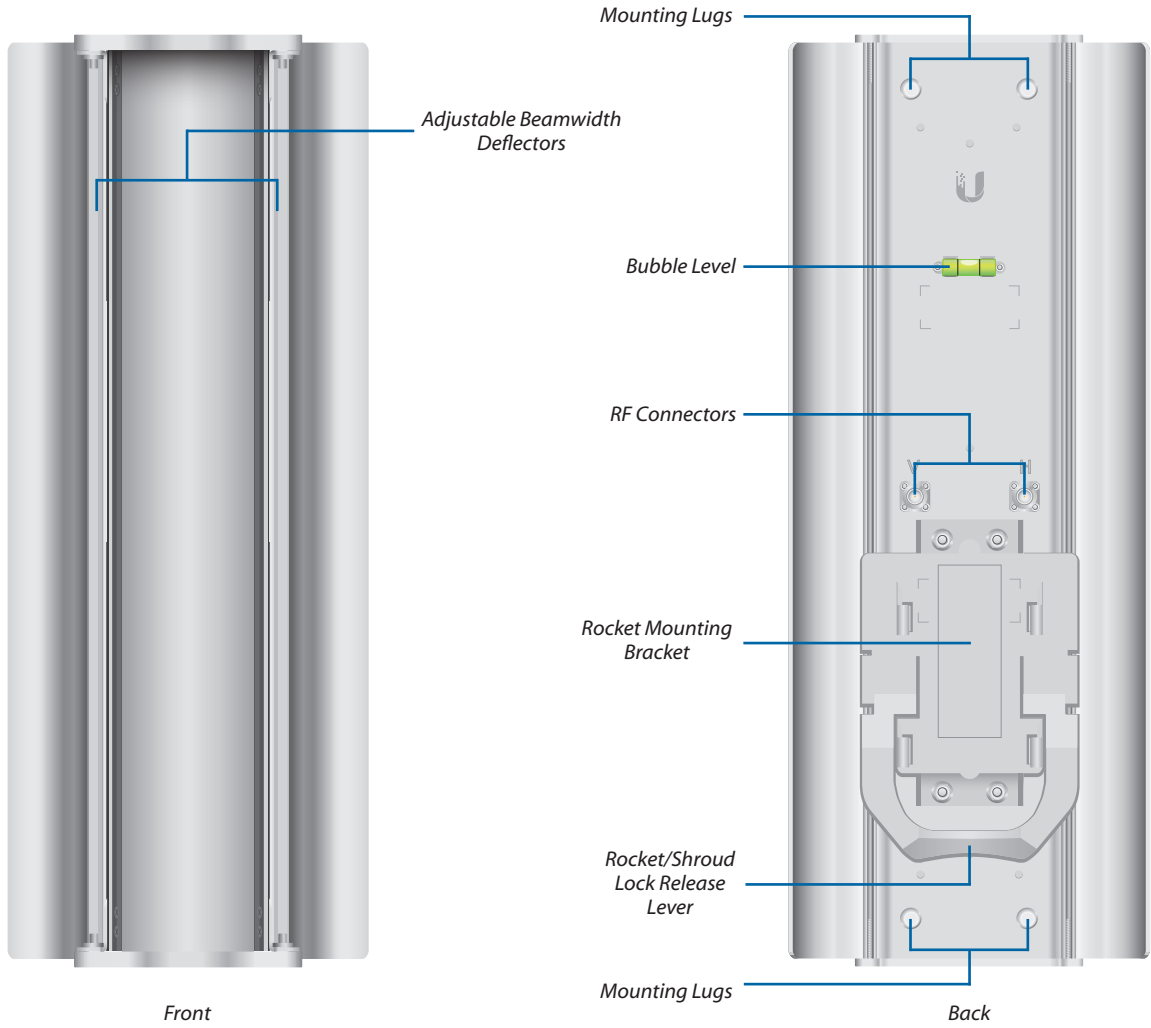

# Specifications

AM-V2G-Ti	
Dimensions	773 x 372 x 120 mm (30.43 x 14.65 x 4.72")
Weight (with Brackets)	6.40 kg (14.11 lb)
Frequency Range	2.3 - 2.6 GHz
Beamwidth Angles	60°/ 90°/ 120°
Gain (Beamwidth Dependent)	
60°	17 dBi
90°	16 dBi
120°	15 dBi
Elevation Beamwidth	9°
Electrical Downtilt	4°
Wind Survivability	200 km/h (125 mph)
Wind Loading	640.5 N @ 200 km/h (144 lbf @ 125 mph)
Polarization	Dual Linear
Cross-Pol Isolation	25 dB Typical
Front-to-Back Ratio	30 dB Typical
Max. VSWR	1.5:1
RF Connectors	2 RP-SMA Connectors (Weatherproof)
Compatible Radios	2.4 GHz Rocket
Mounting	Pole Mount (Kit Included)
ETSI Specification	EN 302 326 DN2
Certifications	CE, FCC, IC

AM-V5G-Ti	
Dimensions	721 x 149.1 x 75.7 mm (28.39 x 5.87 x 2.98")
Weight (with Brackets)	3.72 kg (8.20 lb)
Frequency Range	5.45 - 5.85 GHz
Beamwidth Angles	60°/ 90°/ 120°
Gain (Beamwidth Dependent)	
60°	21 dBi
90°	20 dBi
120°	19 dBi
Elevation Beamwidth	4°
Electrical Downtilt	2°
Wind Survivability	200 km/h (125 mph)
Wind Loading	231 N @ 200 km/h 52 lbf @ 125 mph
Polarization	Dual Linear
Cross-Pol Isolation	25 dB Typical
Front-to-Back Ratio	30 dB Typical
Max. VSWR	1.5:1
RF Connectors	2 RP-SMA Connectors (Weatherproof)
Compatible Radios	5 GHz Rocket
Mounting	Pole Mount (Kit Included)
ETSI Specification	EN 302 326 DN2
Certifications	CE, FCC, IC

# Specifications

AM-M-V5G-Ti	
Dimensions	385 x 149 x 76 mm (15.16 x 5.87 x 2.99")
Weight (with Brackets)	3.25 kg (7.17 lb)
Frequency Range	5.45 - 5.85 GHz
Beamwidth Angles	60°/ 90°/ 120°
Gain (Beamwidth Dependent)	
60°	17 dBi
90°	16 dBi
120°	15 dBi
Elevation Beamwidth	8°
Electrical Downtilt	3°
Wind Survivability	200 km/h (125 mph)
Wind Loading	102 N @ 200 km/h 23 lbf @ 125 mph
Polarization	Dual Linear
Cross-Pol Isolation	25 dB Typical
F/B Ratio	35 dB Typical
Max. VSWR	1.7:1
RF Connectors	2 RP-SMA Connectors (Weatherproof)
Compatible Radios	5 GHz Rocket
Mounting	Pole Mount (Kit Included)
ETSI Specification	EN 302 326 DN2
Certifications	CE, FCC, IC

## AM-V2G-Ti Antenna Information

Vertical Azimuth

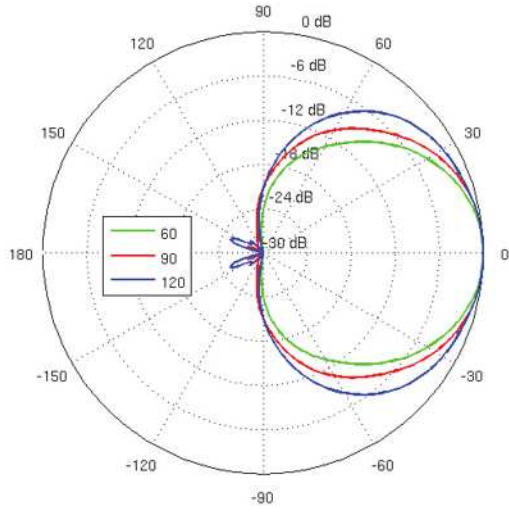

Vertical Elevation

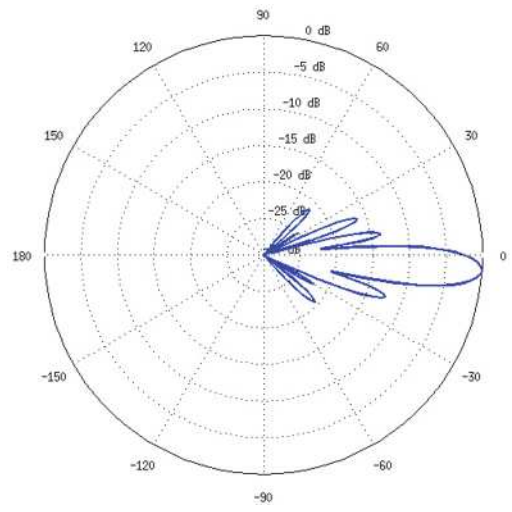

Horizontal Azimuth

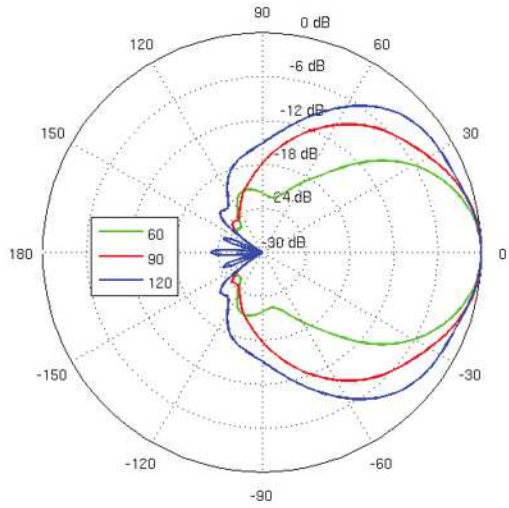

Horizontal Elevation

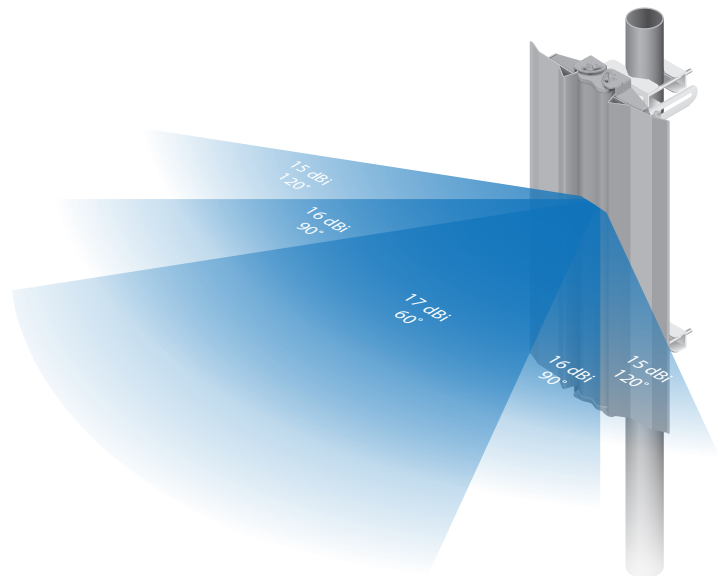
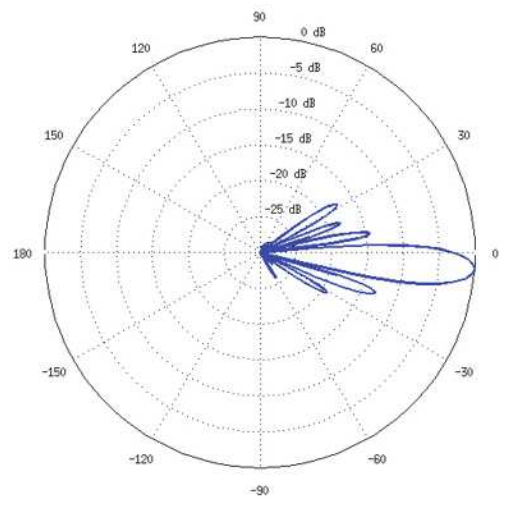



# AM-V5G-Ti Antenna Information

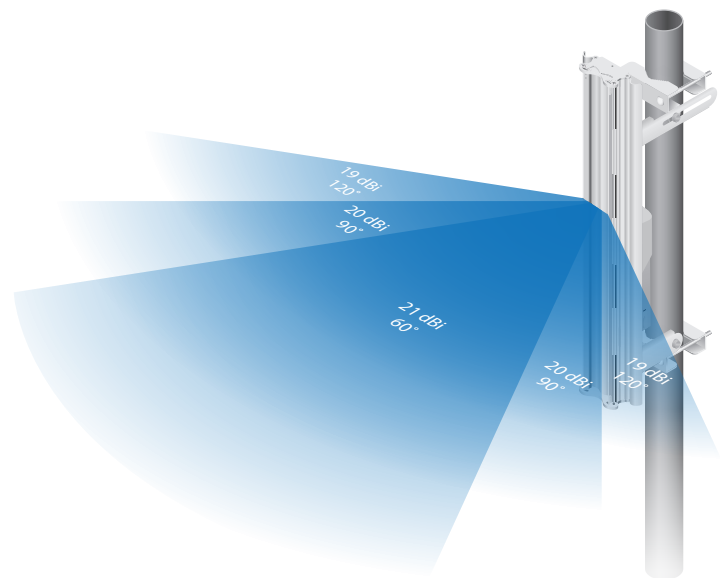
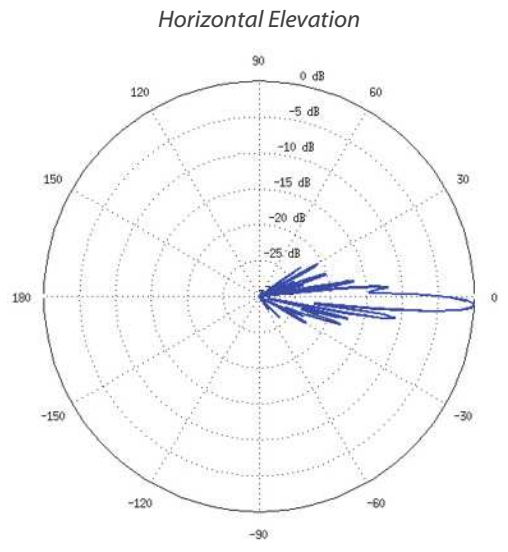
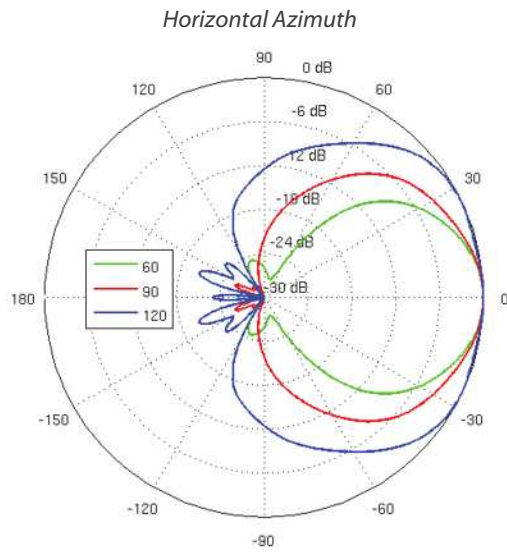
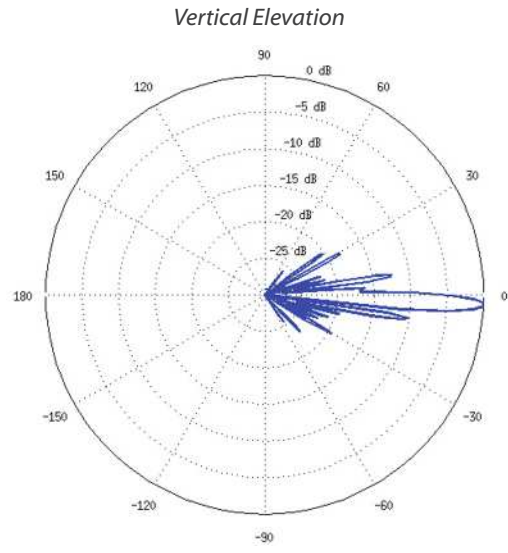
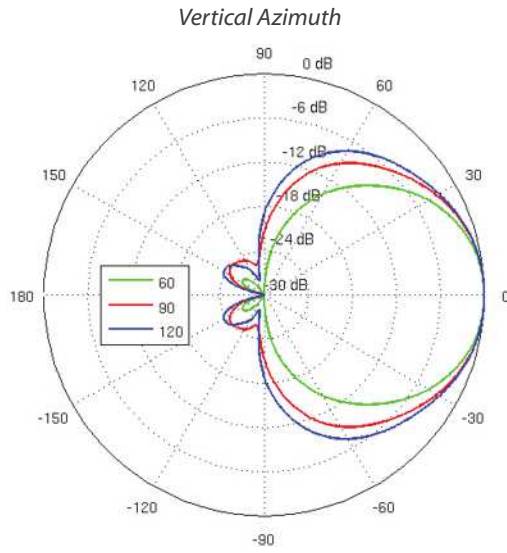

## AM-M-V5G-Ti Antenna Information

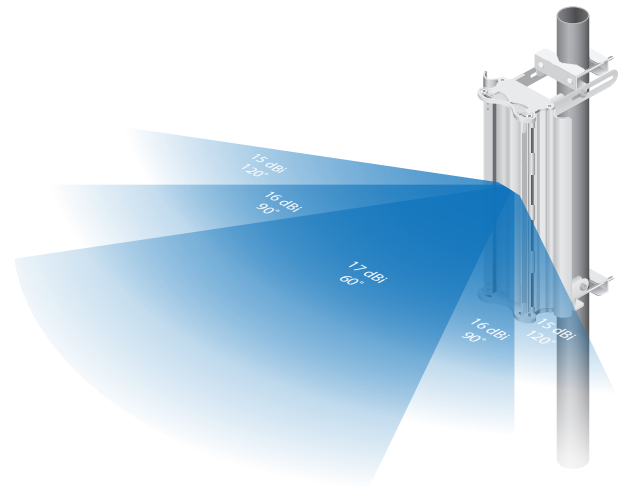
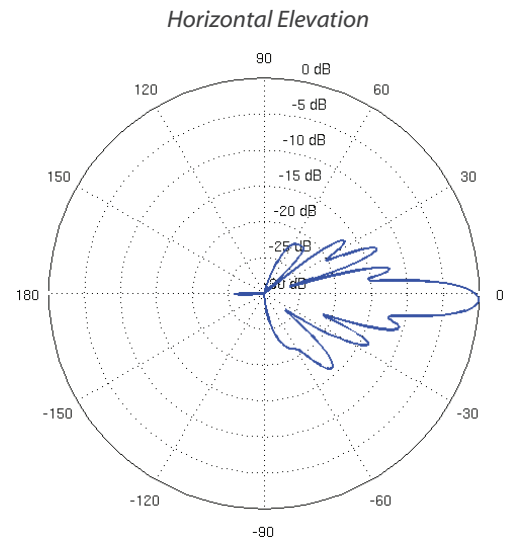
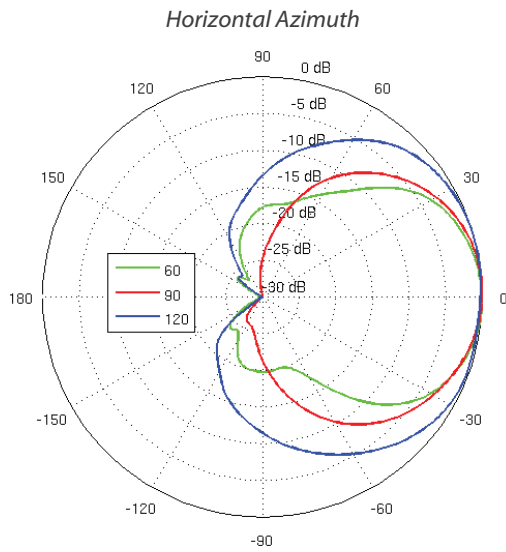
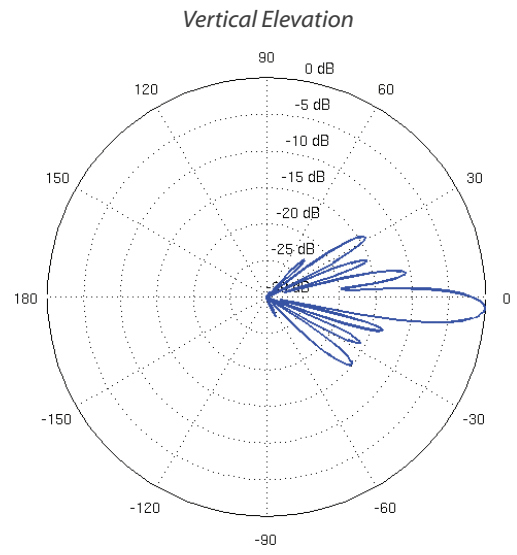
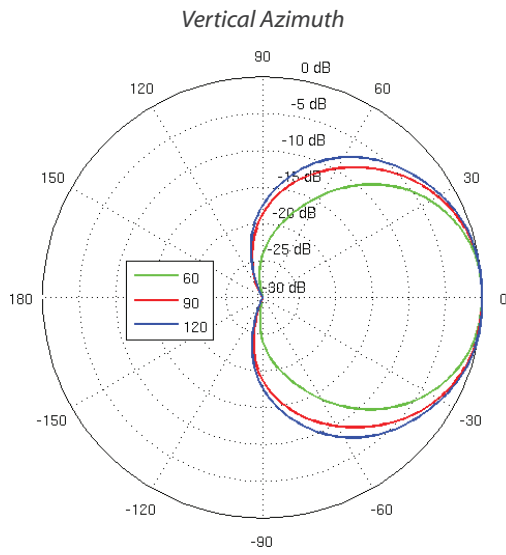

Specifications are subject to change. Ubiquiti products are sold with a limited warranty described at: [www.ubnt.com/support/warranty](http://www.ubnt.com/support/warranty)  
 ©2013-2019 Ubiquiti Networks, Inc. All rights reserved. Ubiquiti, Ubiquiti Networks, the Ubiquiti U logo, the Ubiquiti beam logo, airMAX, airOS, and Rocket are trademarks or registered trademarks of Ubiquiti Networks, Inc. in the United States and in other countries. All other trademarks are the property of their respective owners.



[www.ubnt.com](http://www.ubnt.com)